

REAZIONI  
VINCOLARI

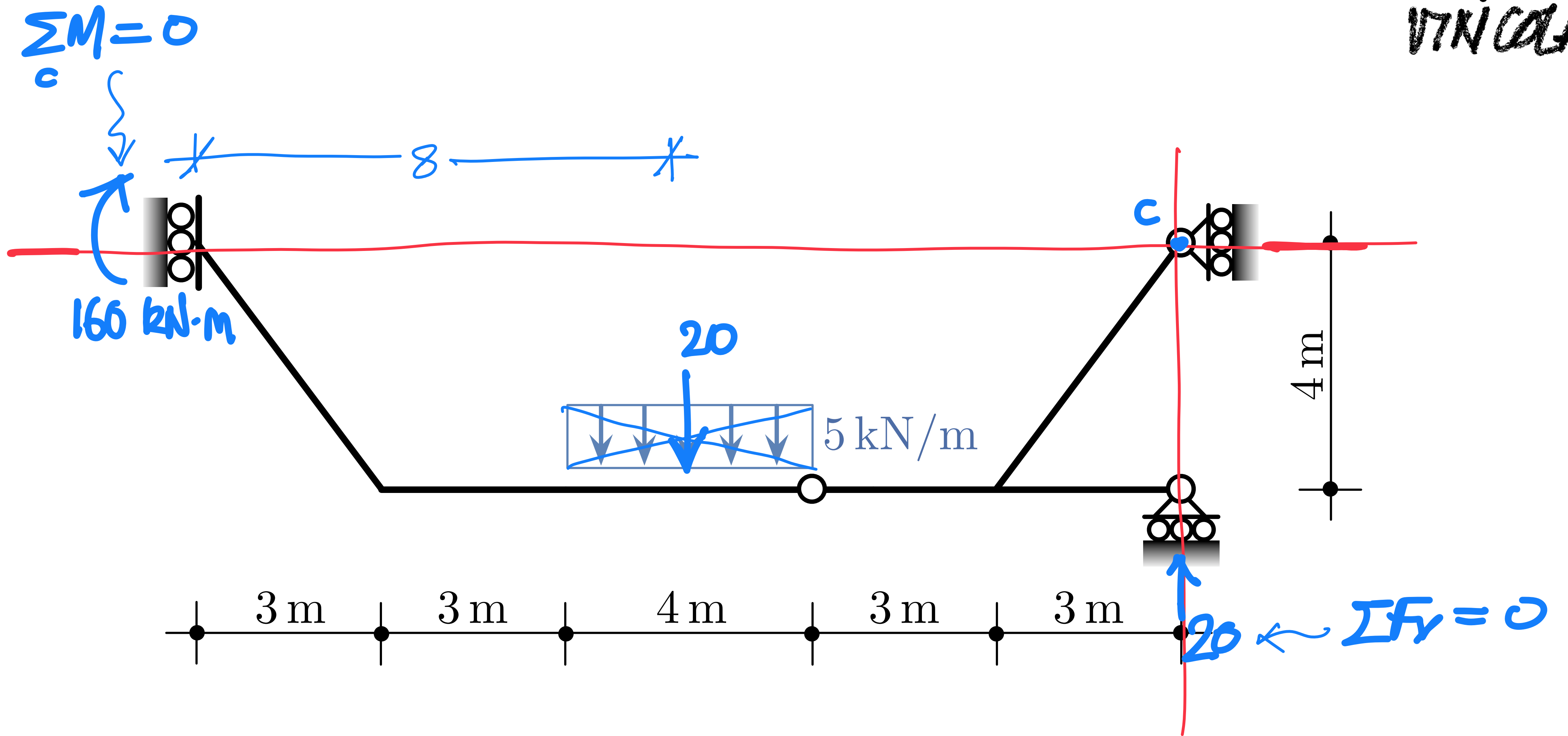

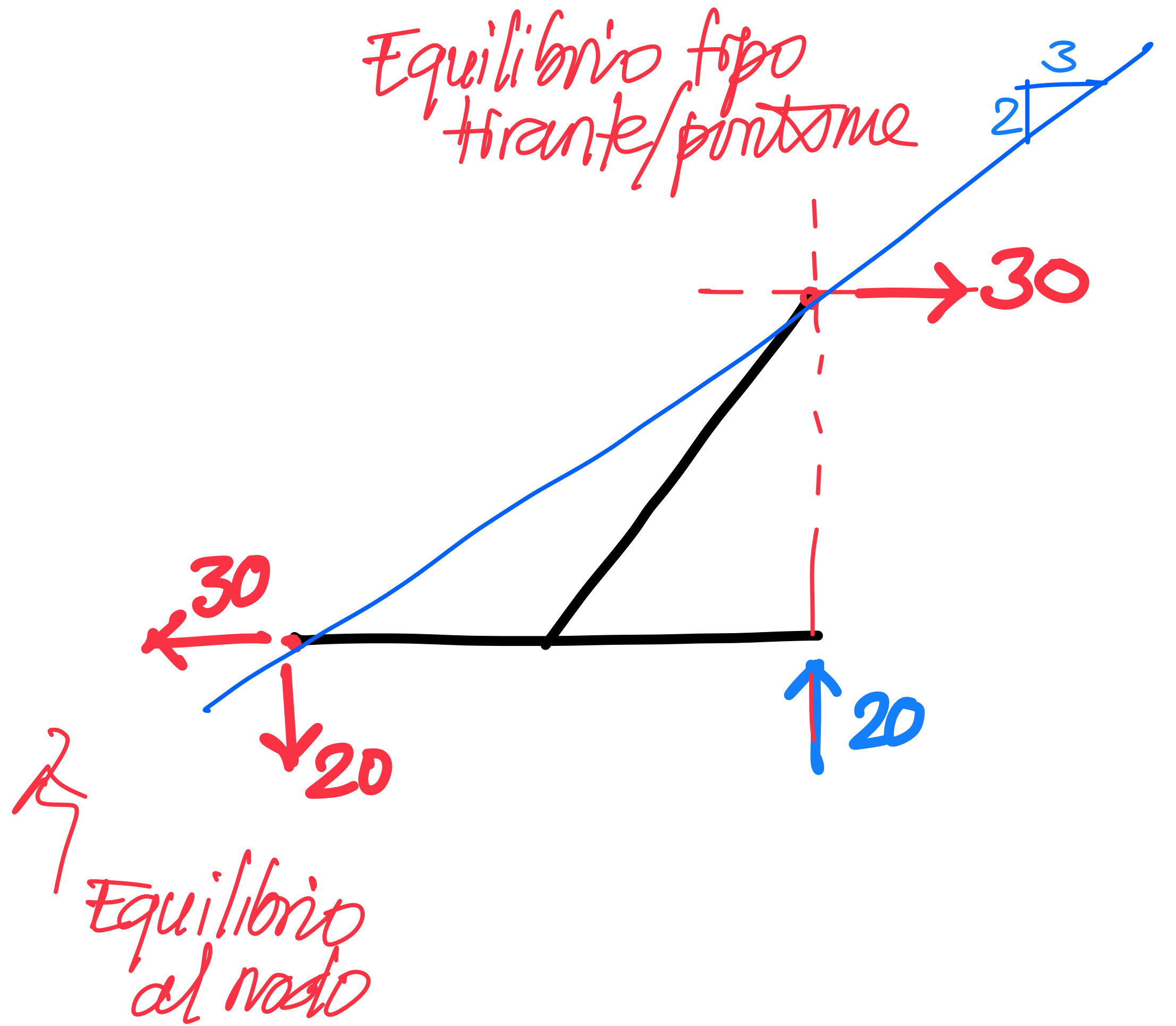

EQUILIBRIO PER  
TRATTI CON N, T, M  
FUNZIONI CONTINUE

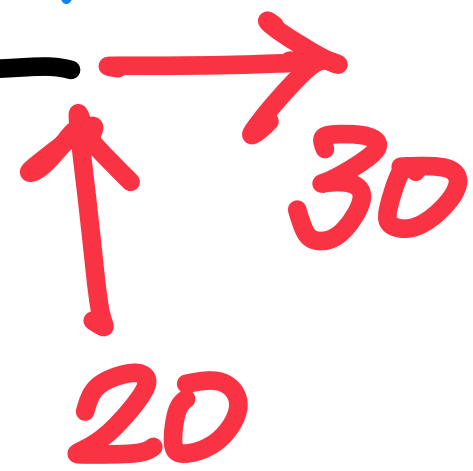
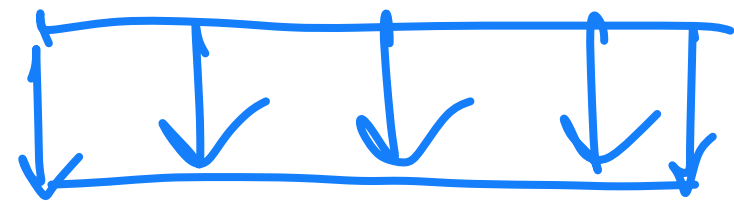
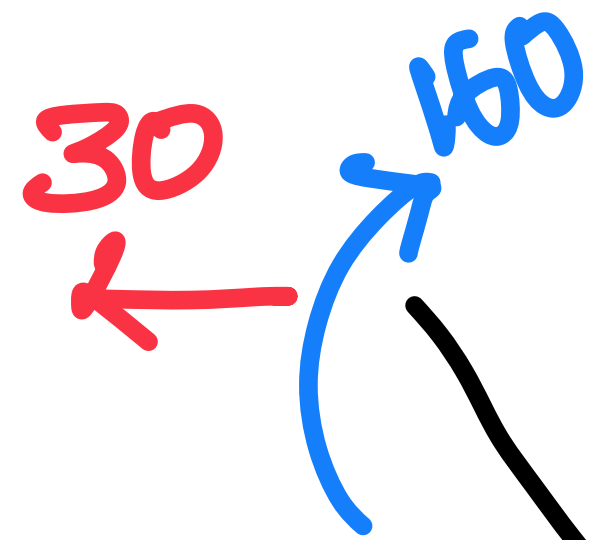
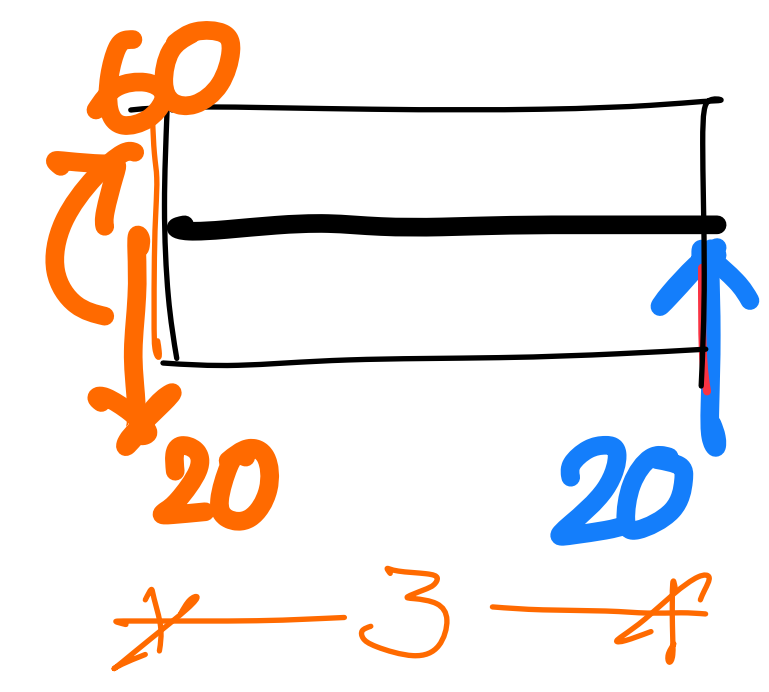
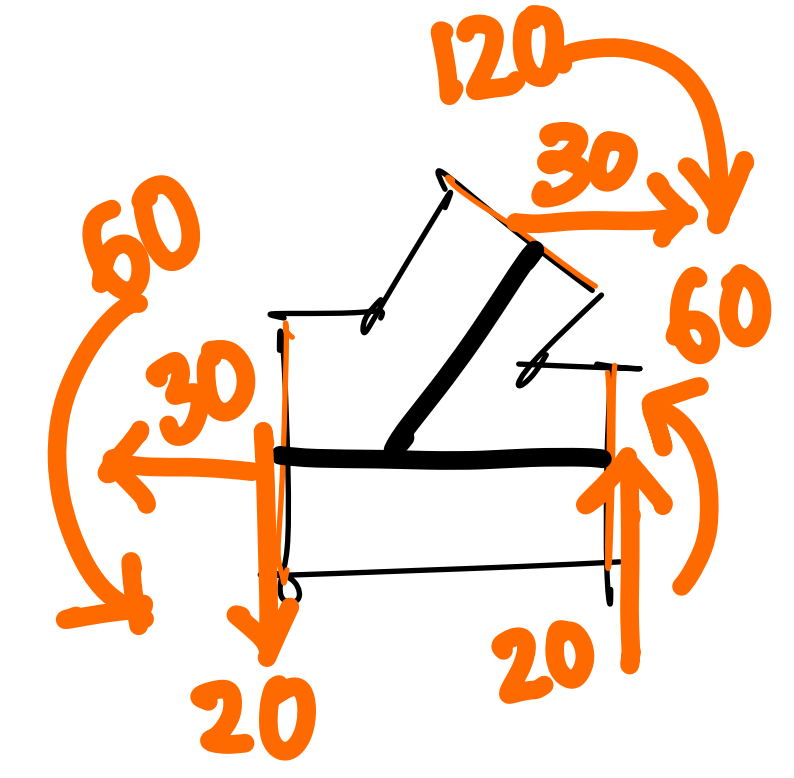
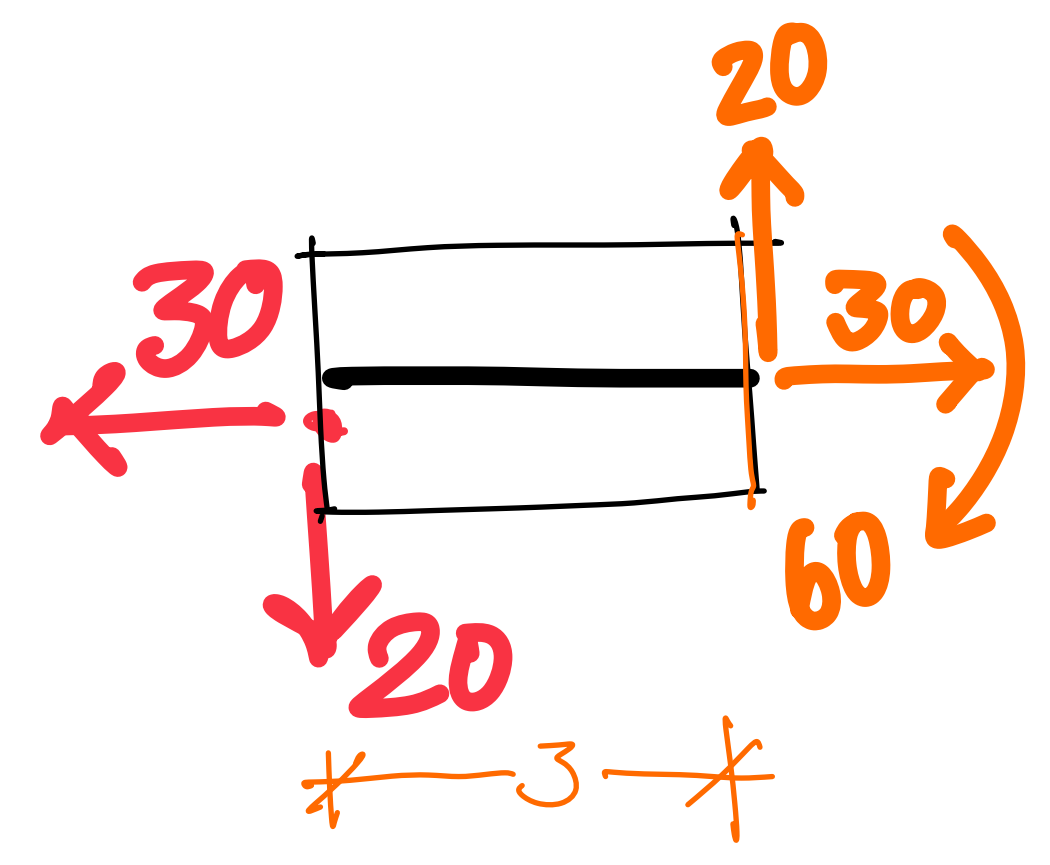
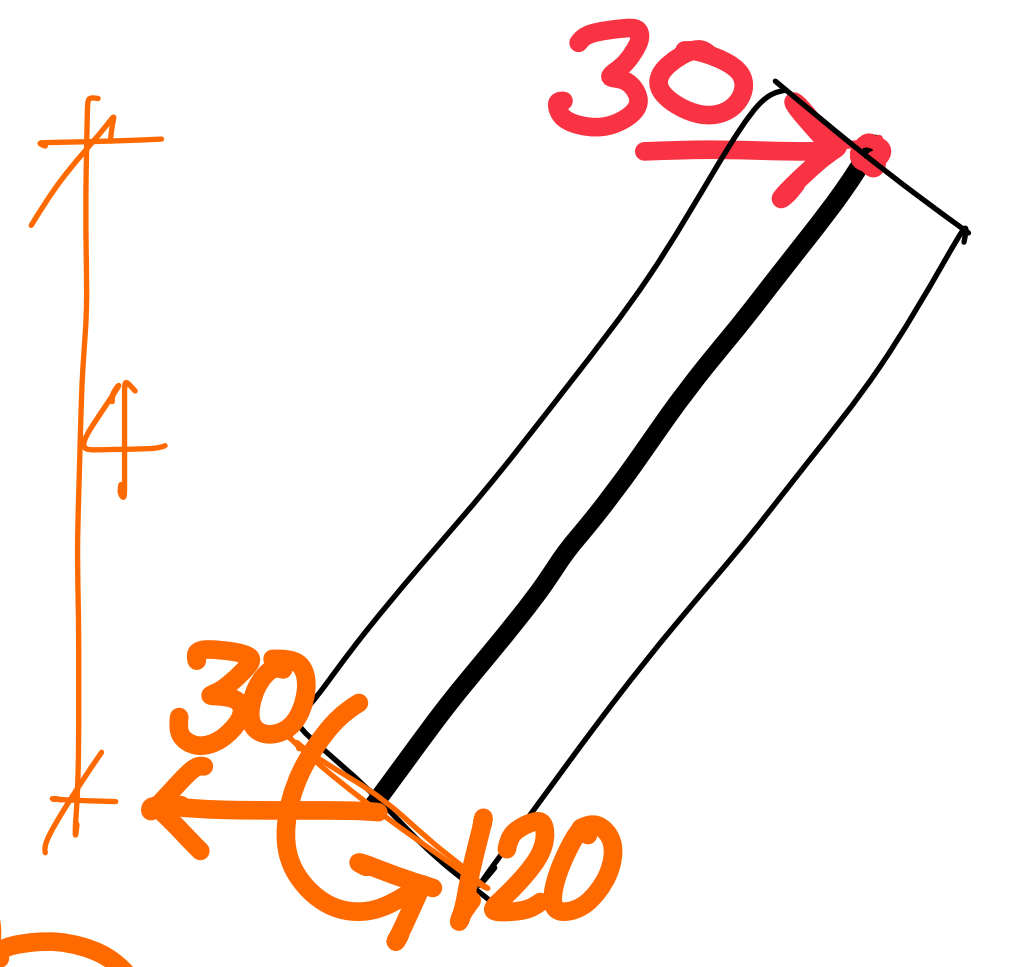
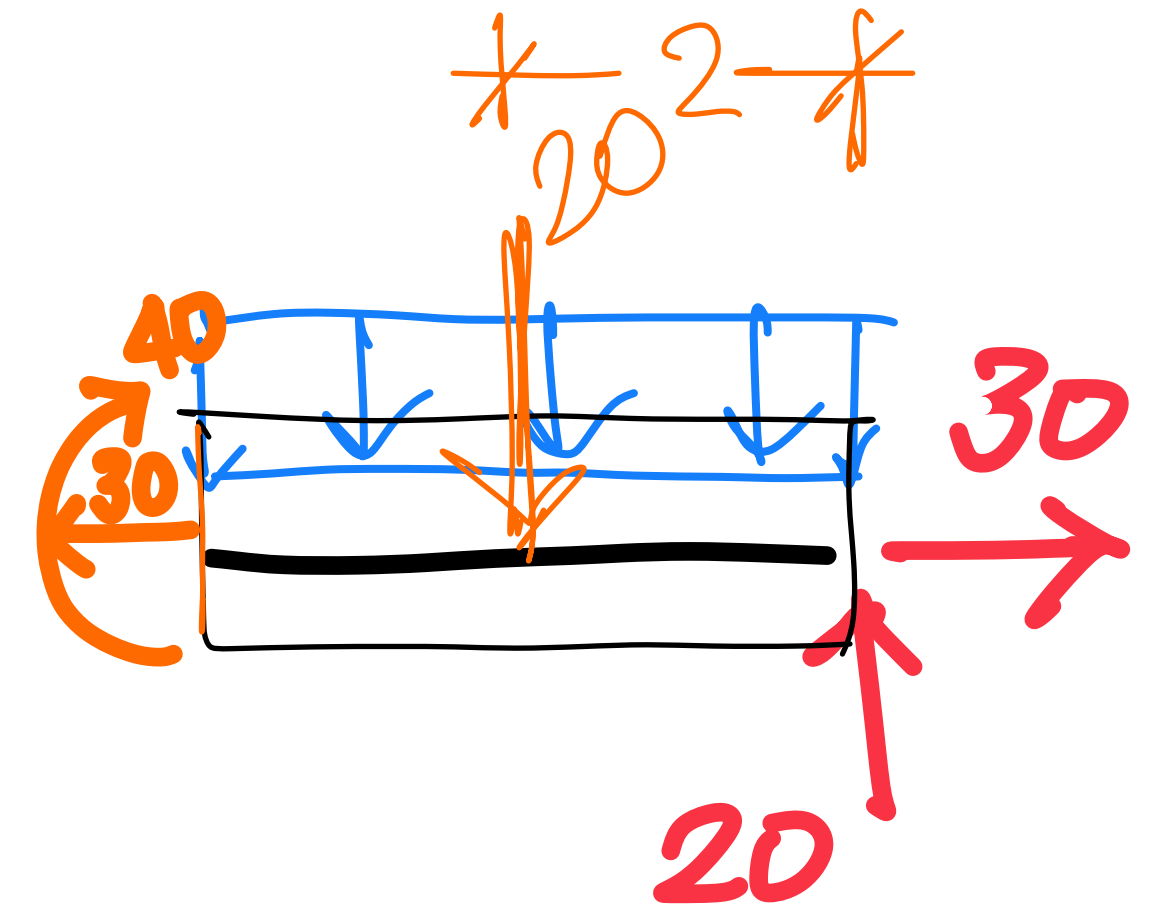
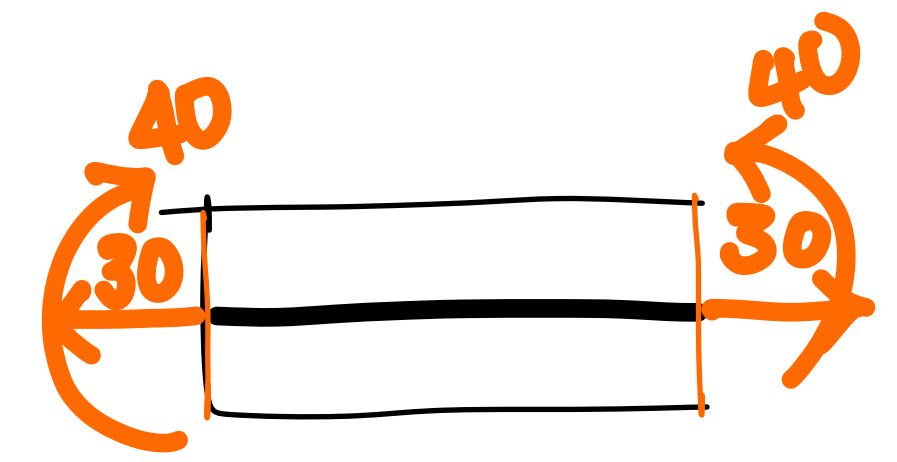
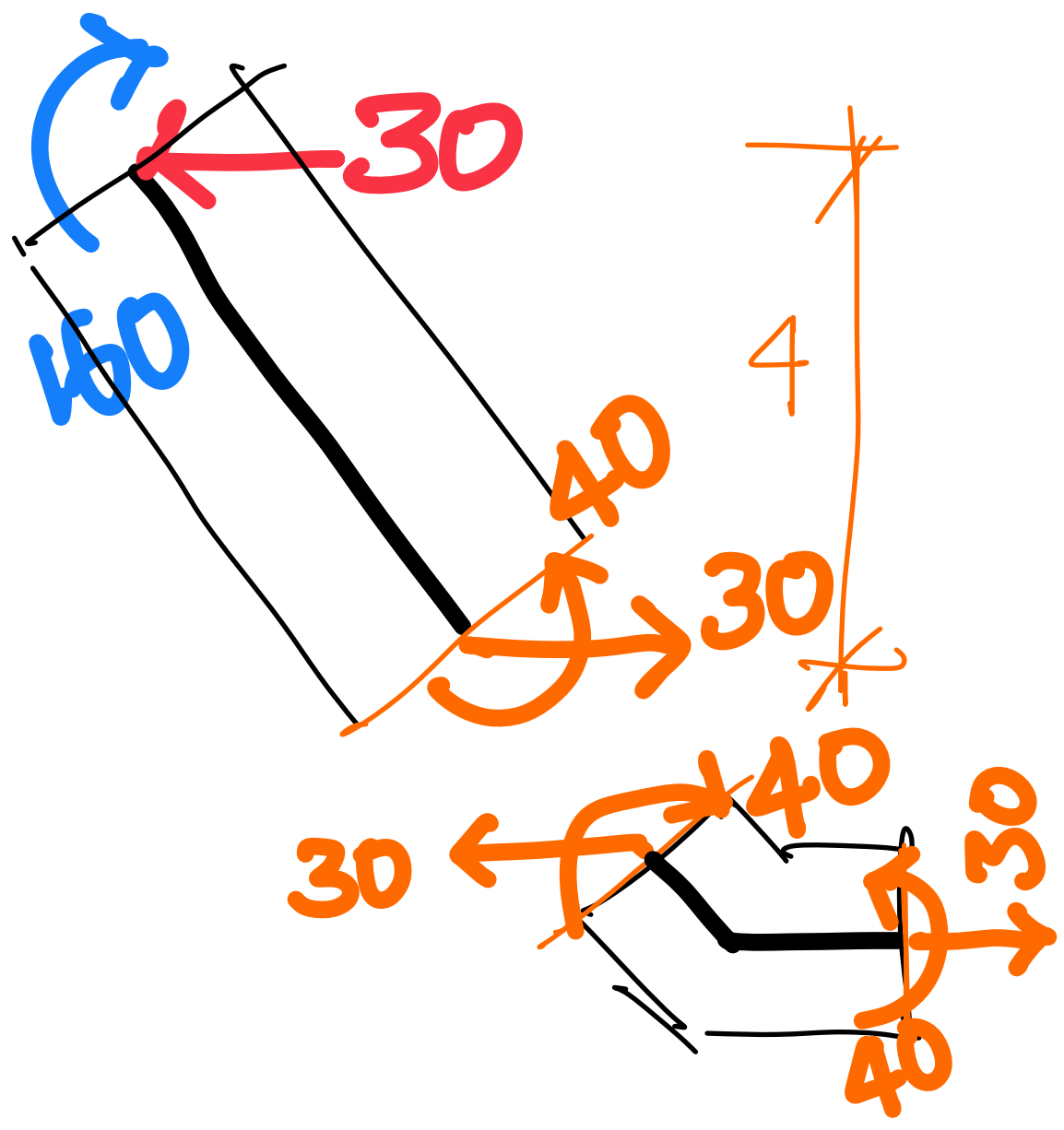

EQUILIBRIO PER  
TRATTI CON N, T, M  
FUNZIONI CONTINUE

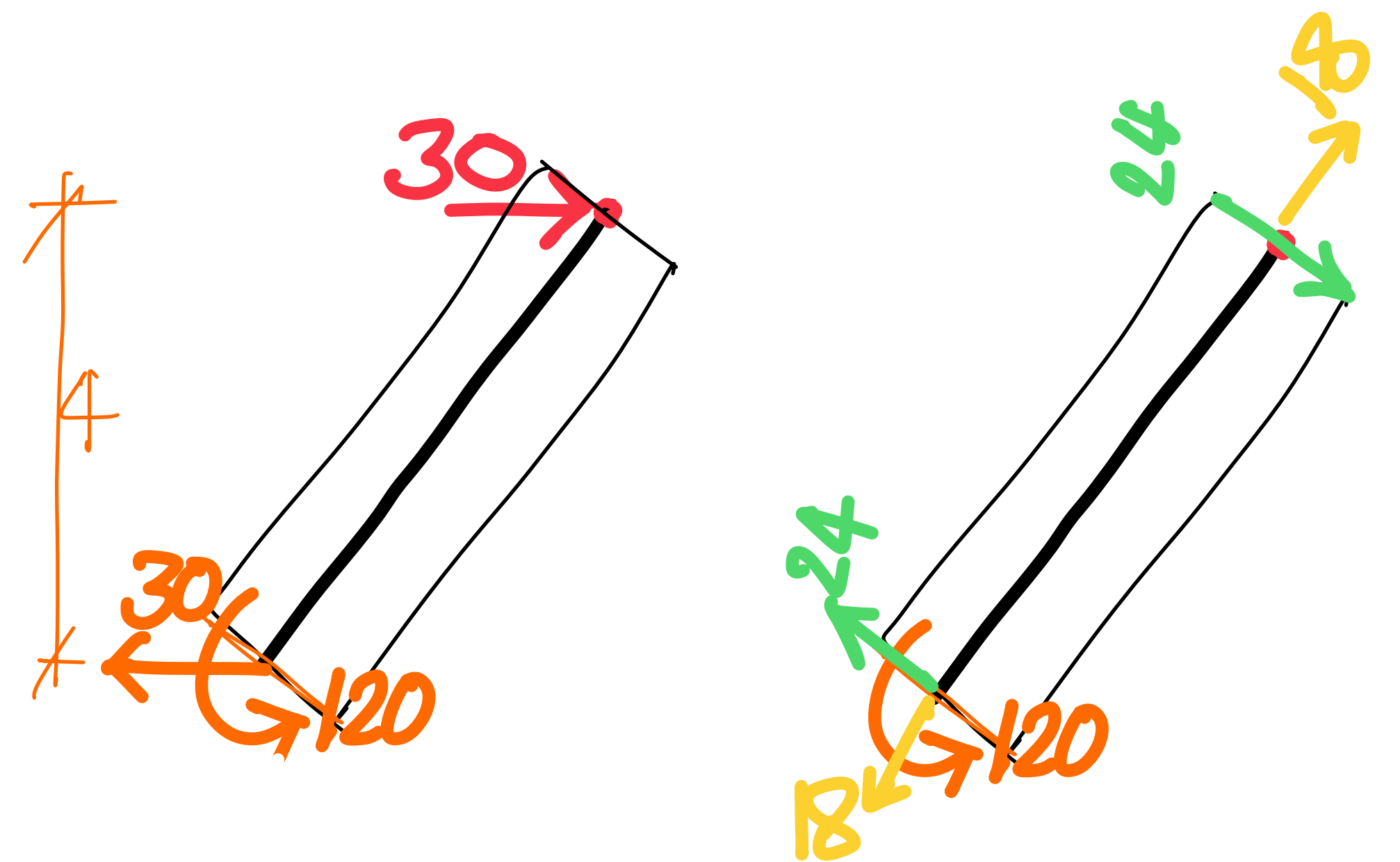
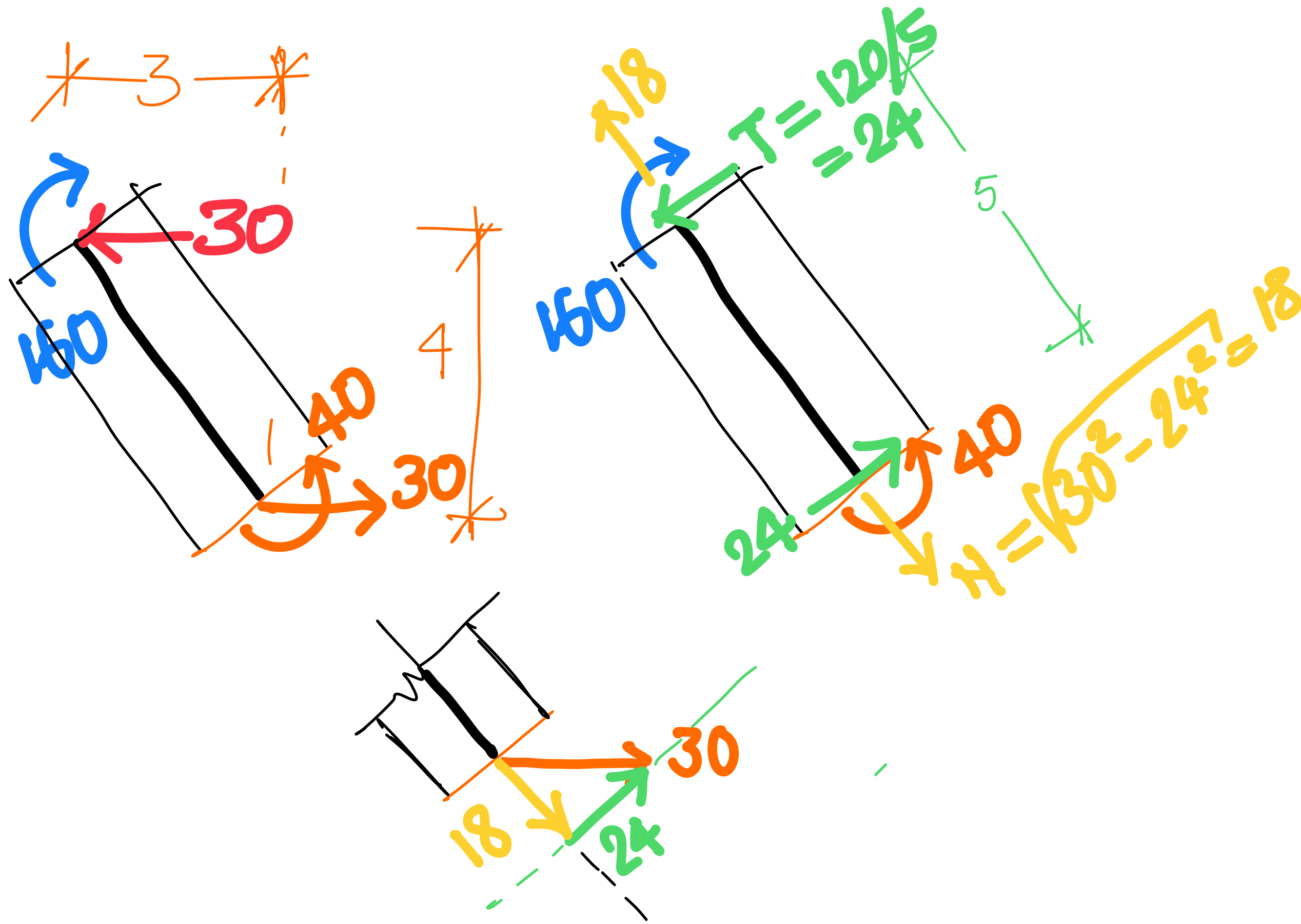

# DIAGRAMMA N

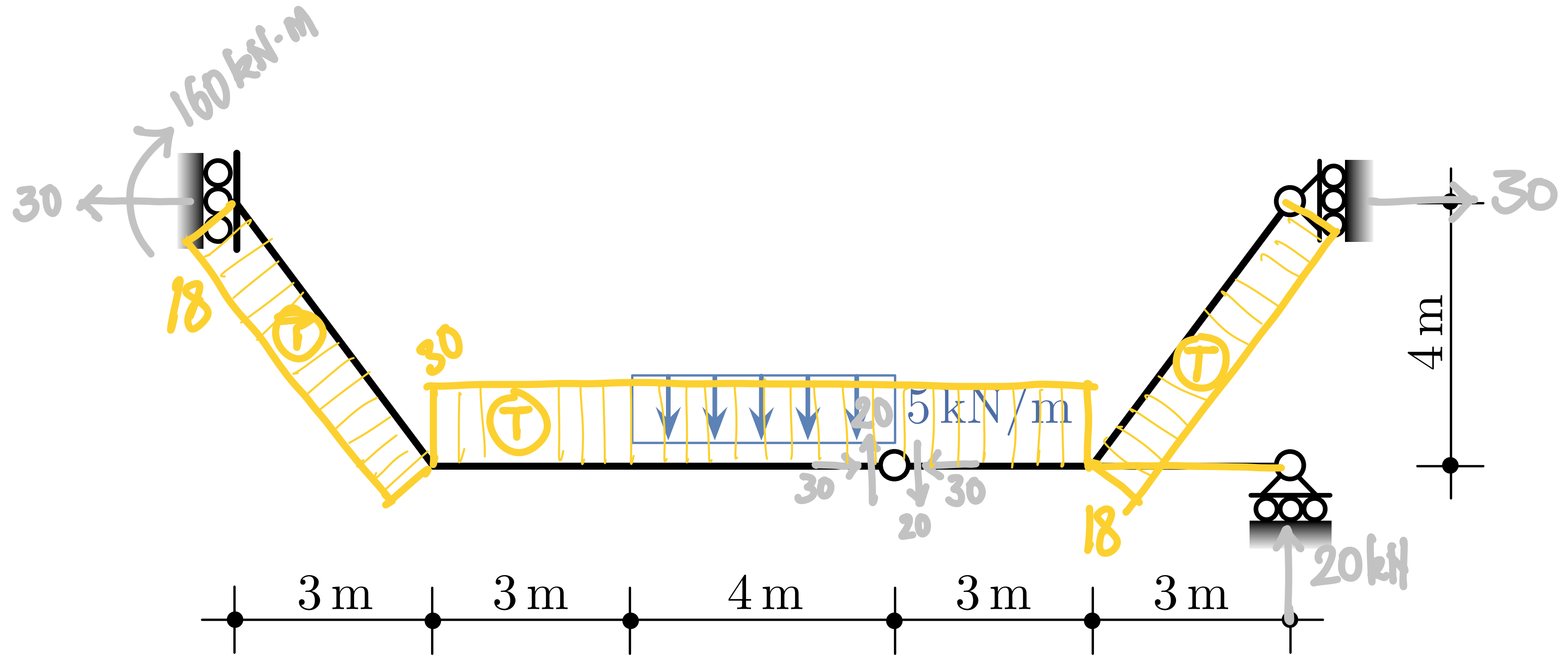

# DIAGRAMMA T

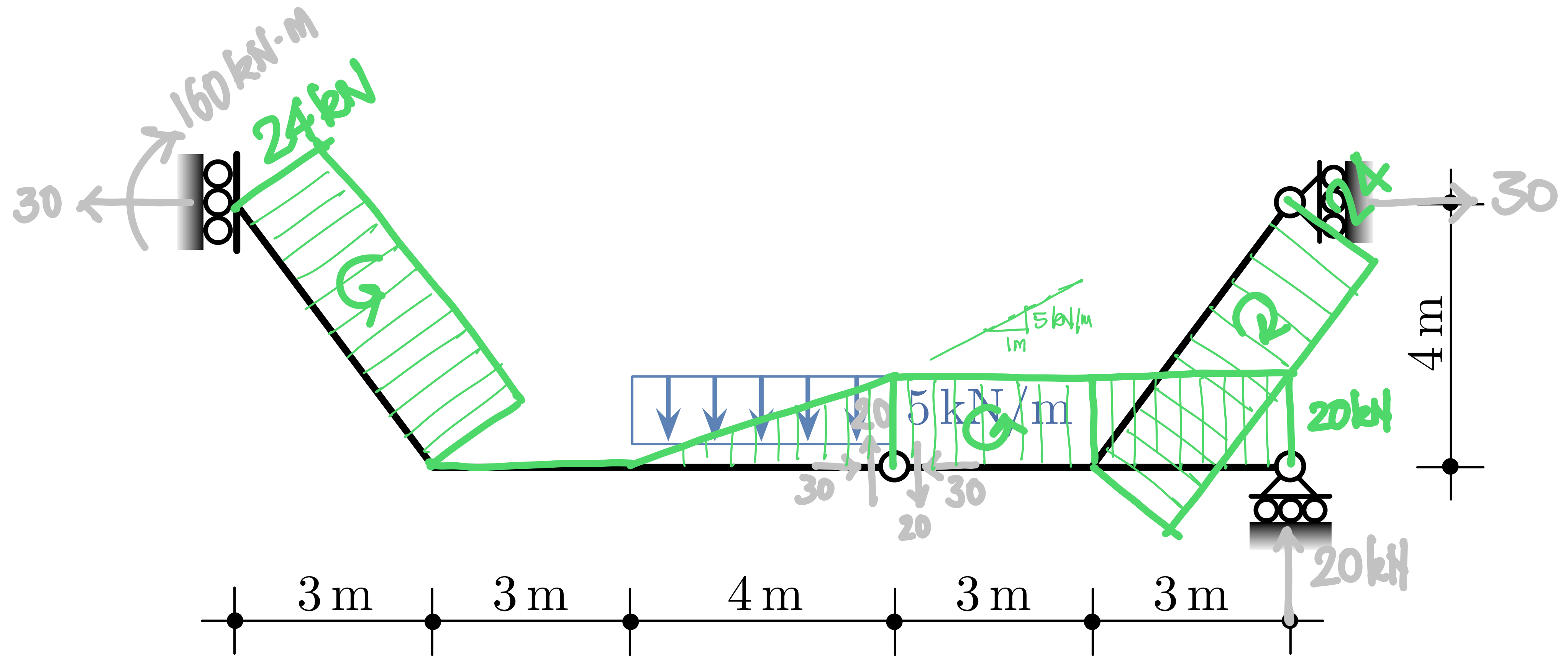

# DIAGRAMMA M

