

TRACCIA F

# CALCOLO delle REAZIONI VINCOLARI con metodo dei corpi liberi

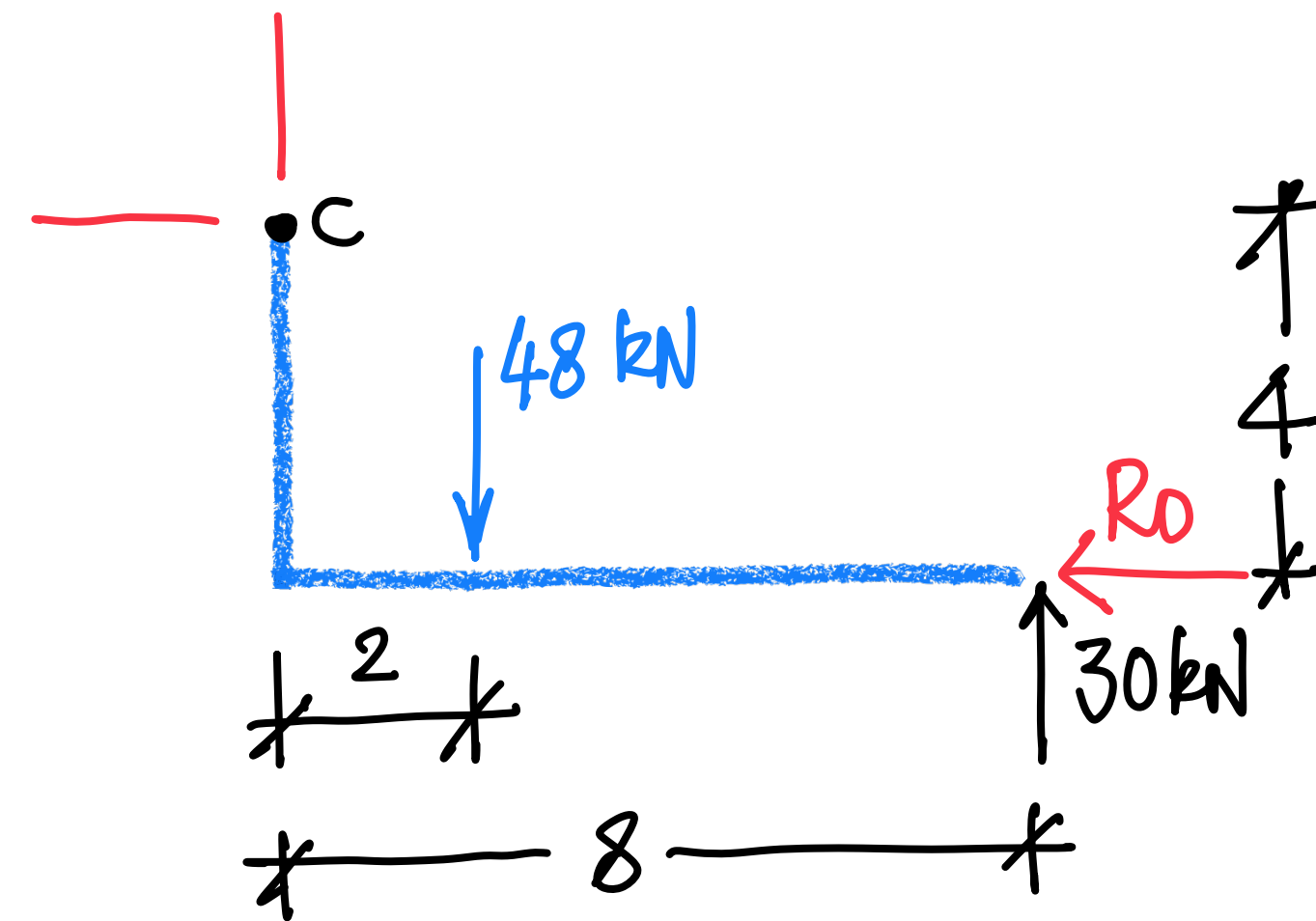
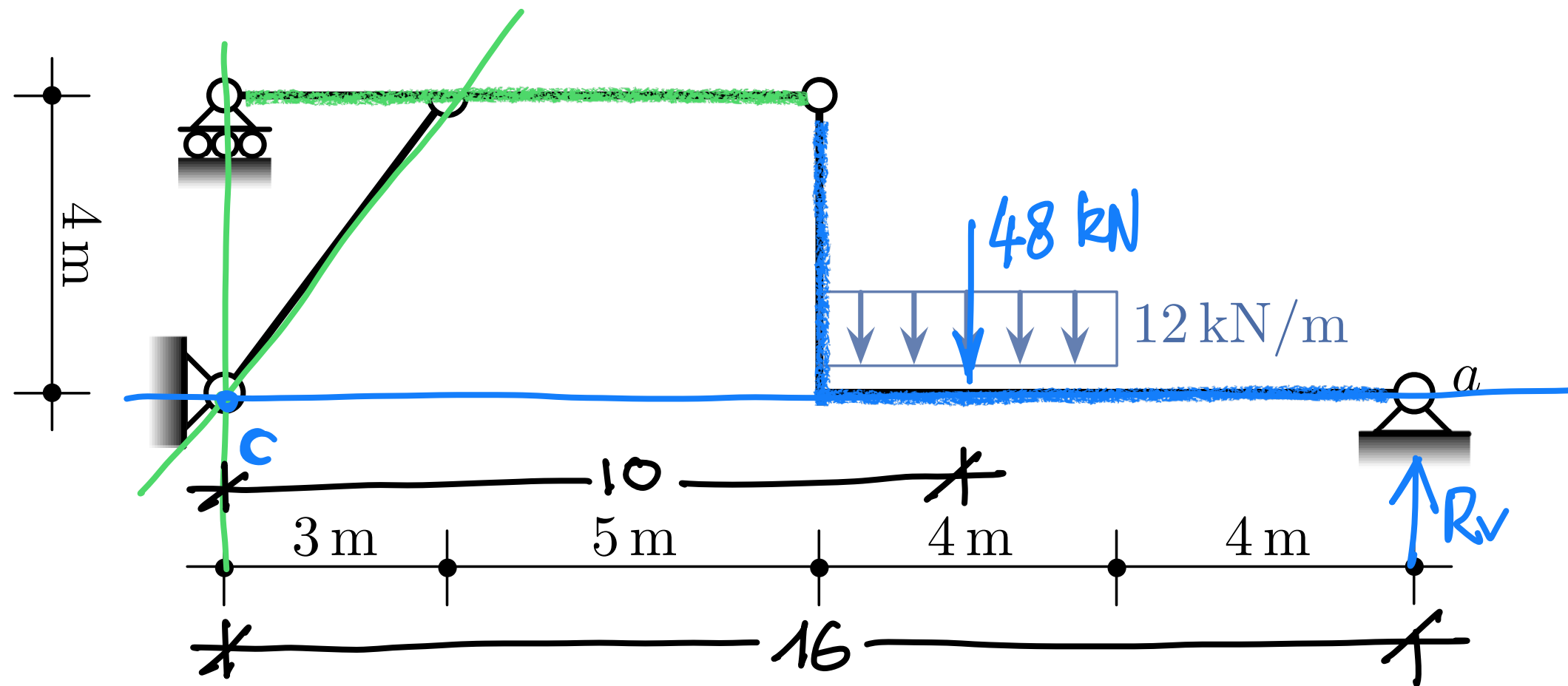

## 1. EQUILIBRIO GLOBALE

$$\sum_c M = 48 \times 10 - R_v \times 16 = 0$$

↻                  ↺

$$\Rightarrow R_v = 30 \text{ kN}$$

## 2. EQUILIBRIO LOCALE

$$\sum_c M = 48 \times 2 - 30 \times 8 + R_0 \times 4 = 0$$

↻                  ↺                  ↻

$$R_0 = 36 \text{ kN}$$

### 3. EQUILIBRIO LOCALE

$$\sum F_b = 0, \sum F_v = 0$$

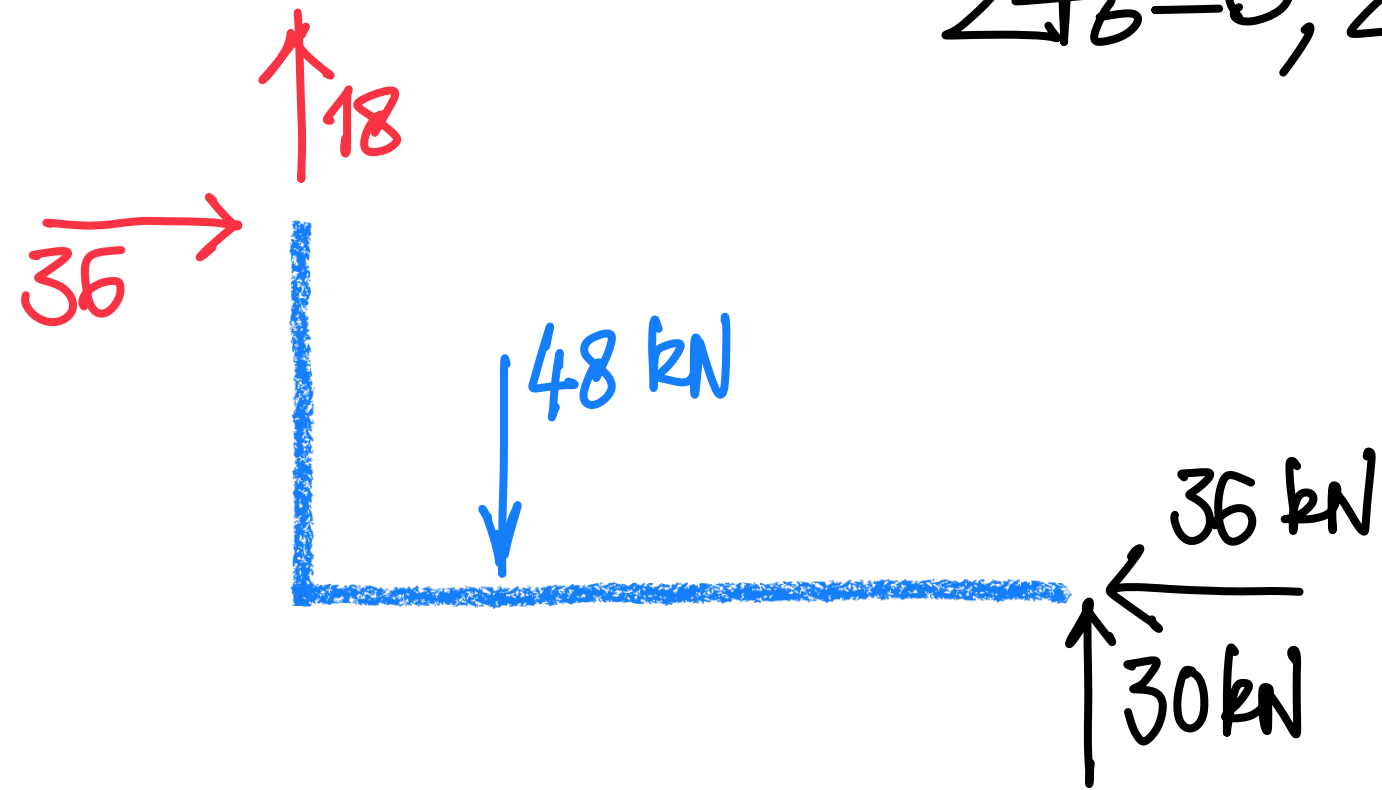

### 4. EQUILIBRIO GLOBALE

$$\sum F_b = 0, \sum F_v = 0$$

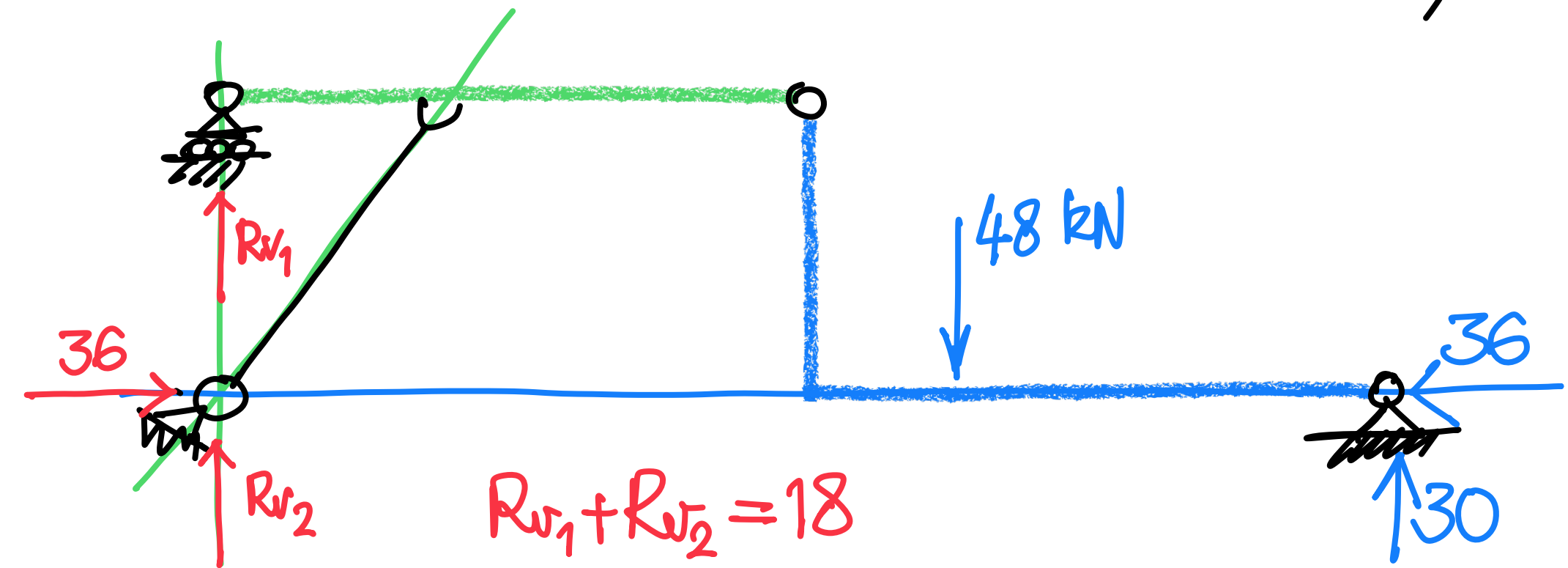

### 5. EQUILIBRIO LOCALE (TIRANTE/PUNTONE)

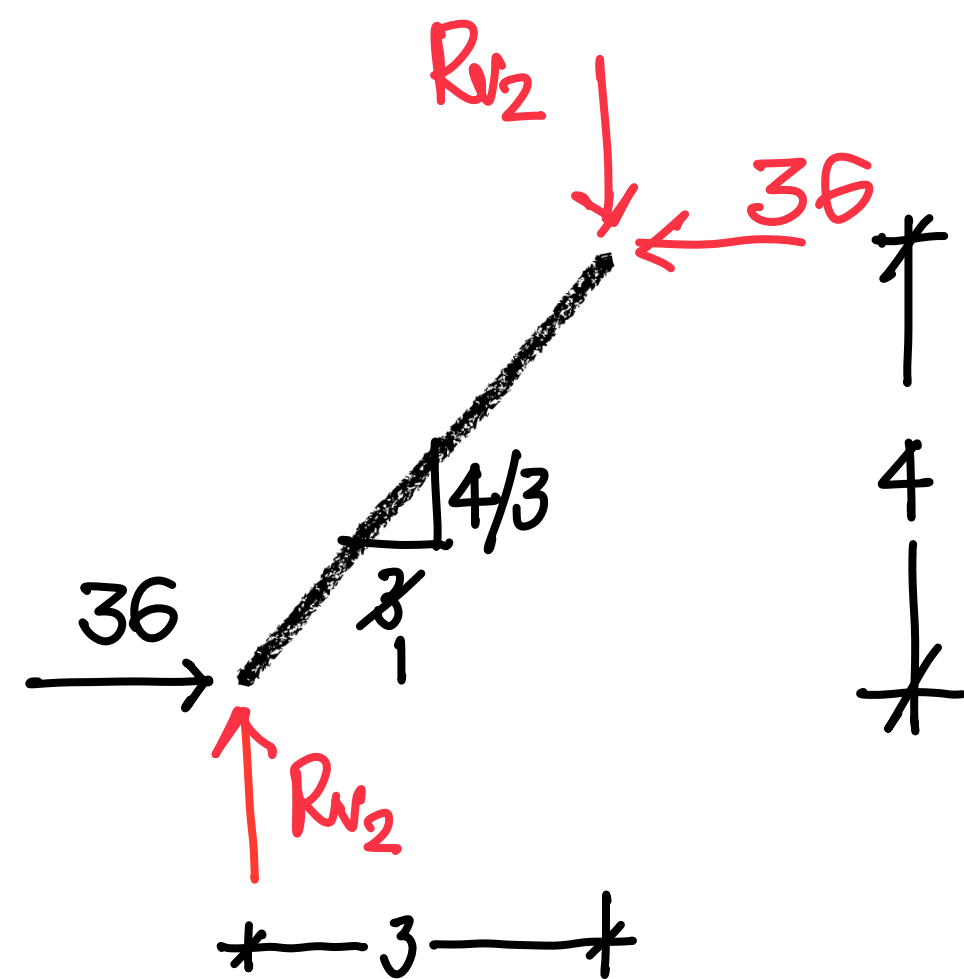

$$\sum M = 36 \times 4 - R_{v2} \times 3 = 0$$

$$\Rightarrow R_{v2} = 48 \text{ kN}$$

### 6. EQUILIBRIO GLOBALE

$$\sum F_v = 0$$

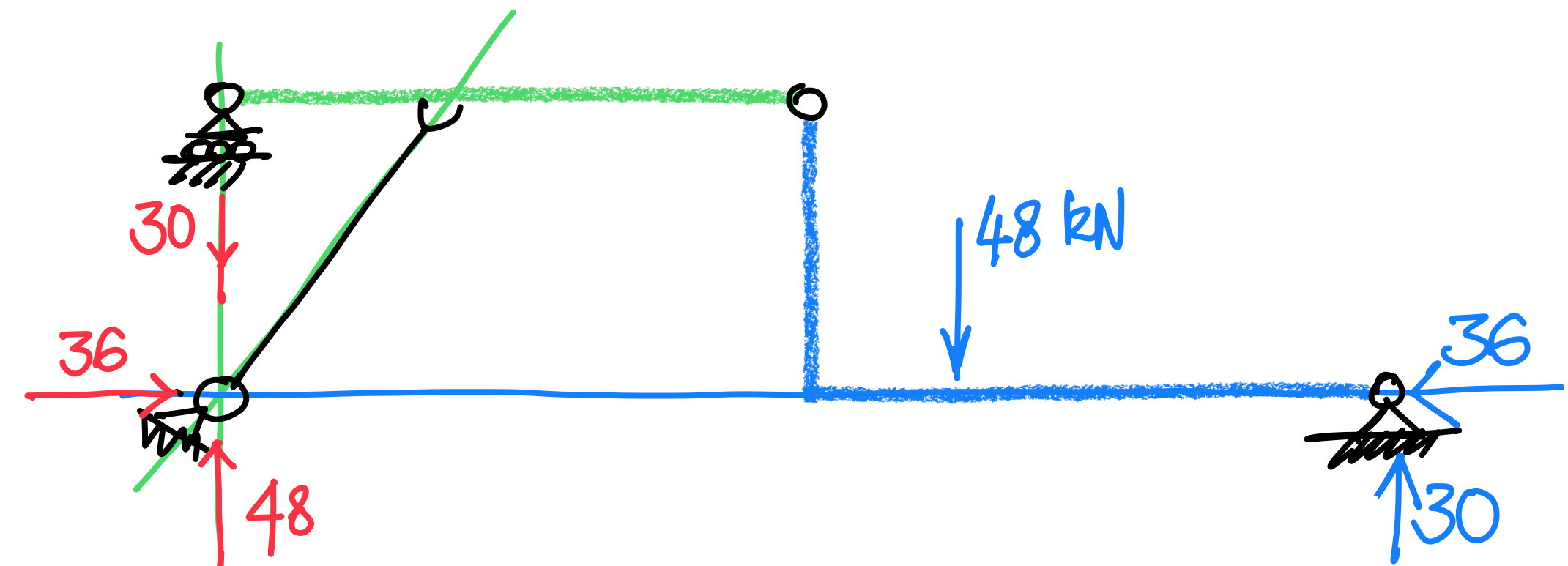

7. EQUILIBRIO LOCALE : verifica dei risultati ottenuti

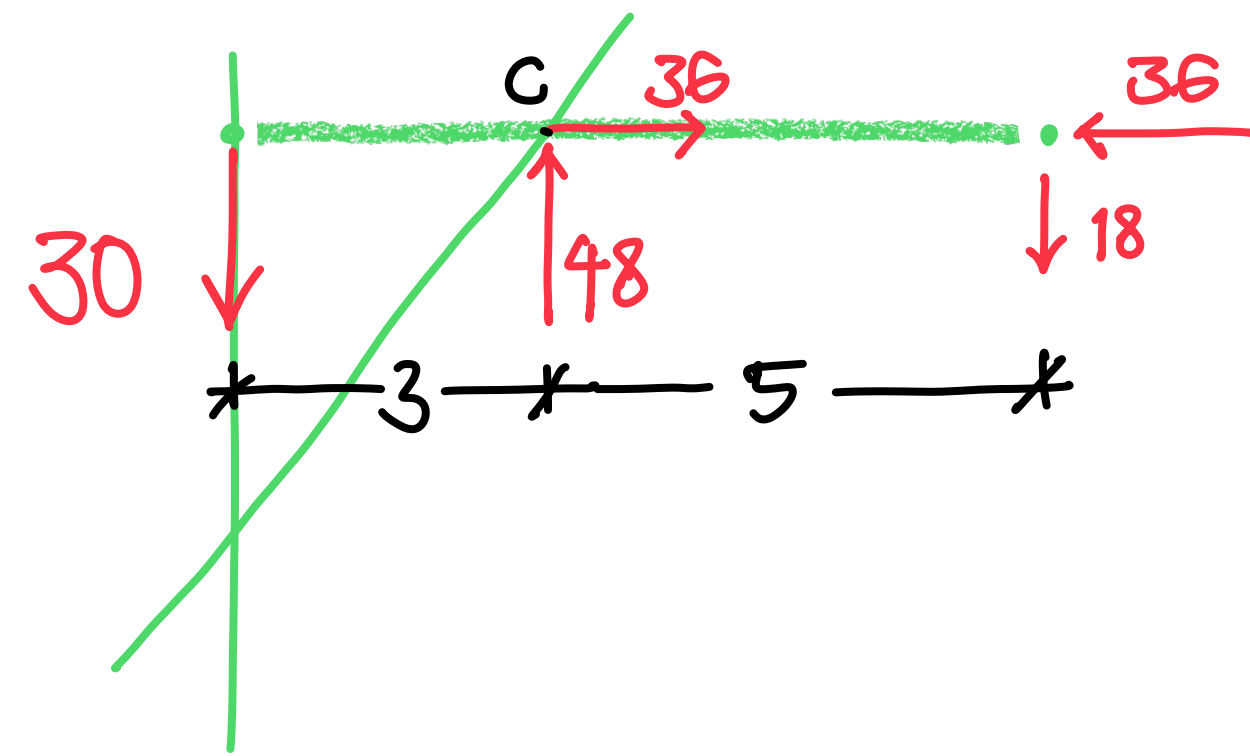

equilibrio tipo-leve:

$$\sum_c M = 30 \times 3 - 18 \times 5 = 0$$

G      ↻

✓

RISULTATO FINALE:

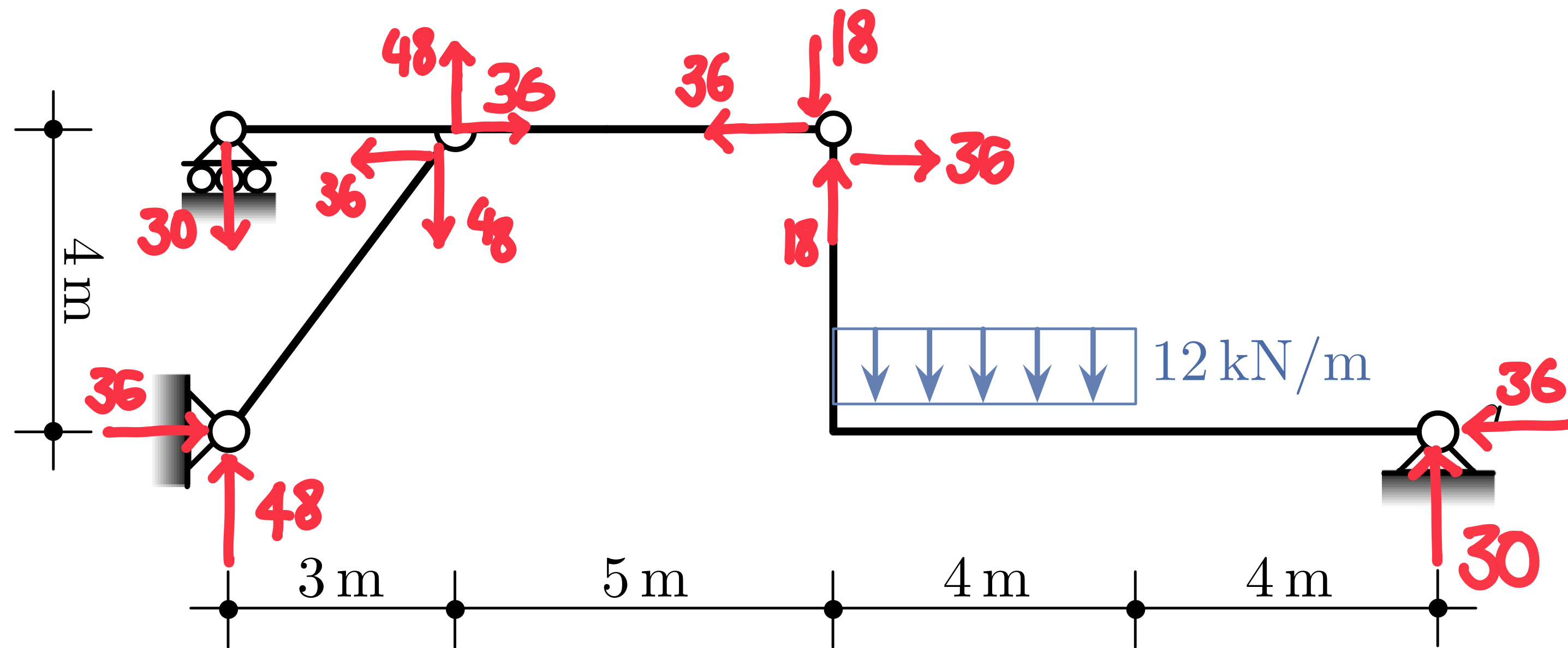

# CALCOLO di $R_0(a)$ con metodo della patente

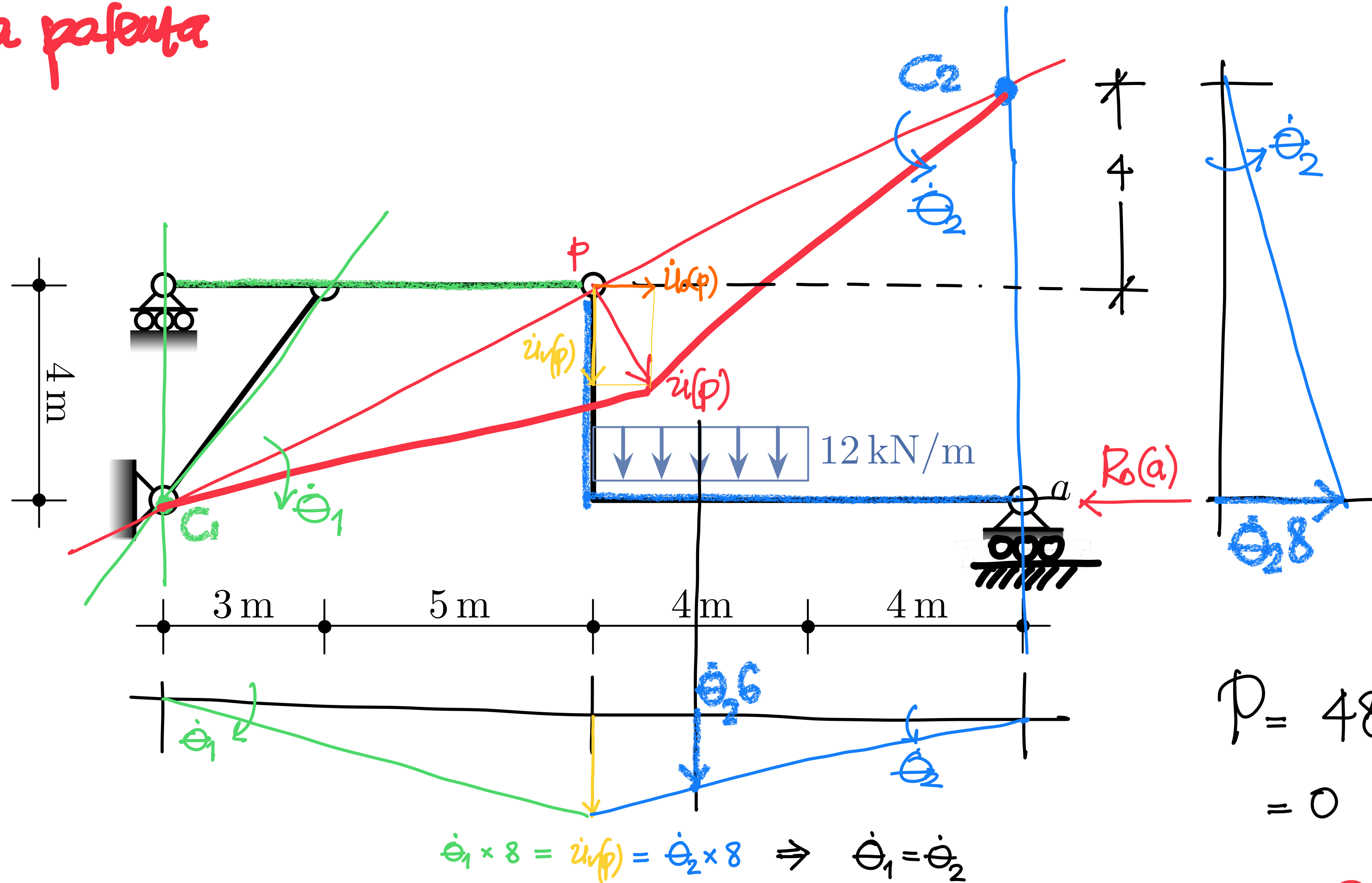

$$\begin{aligned} \mathcal{P} &= 48 \times \dot{\theta}_2 \cdot 6 - R_0(a) \times \dot{\theta}_2 \cdot 8 \\ &= 0 \quad \forall \dot{\theta}_2 \end{aligned}$$

$$\Rightarrow R_0(a) = 36 \text{ kN}$$

# SEZIONAMENTI per N, T, M continue

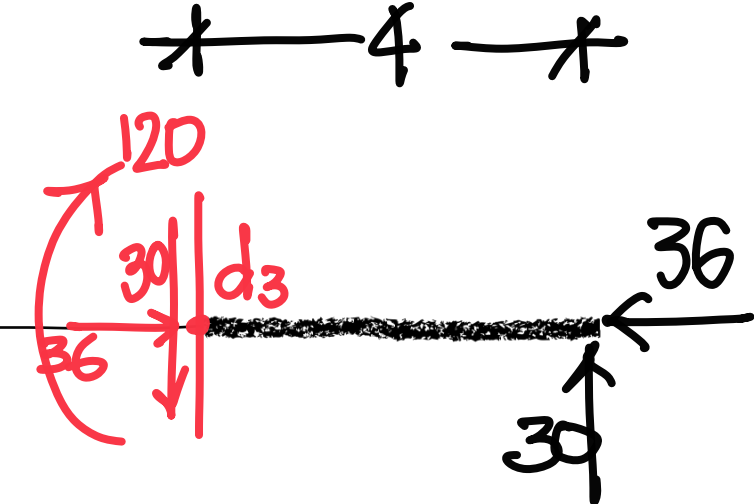
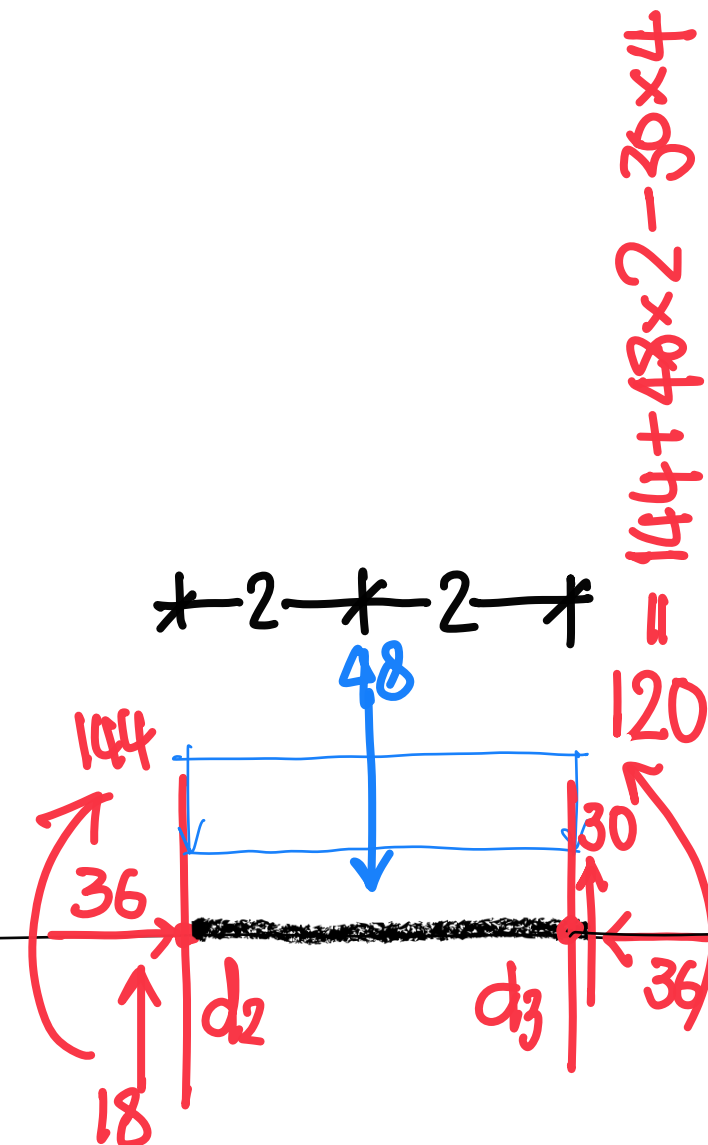
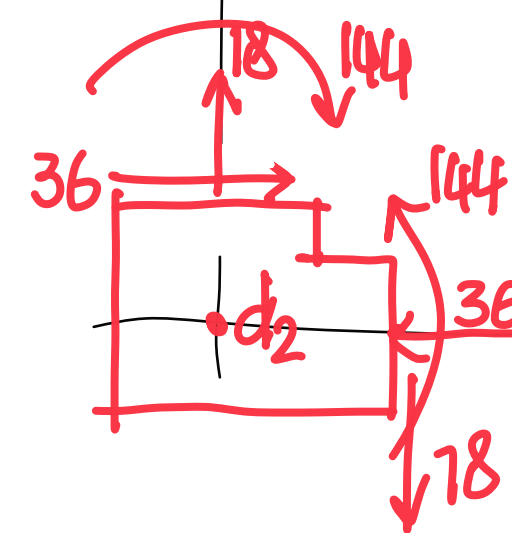
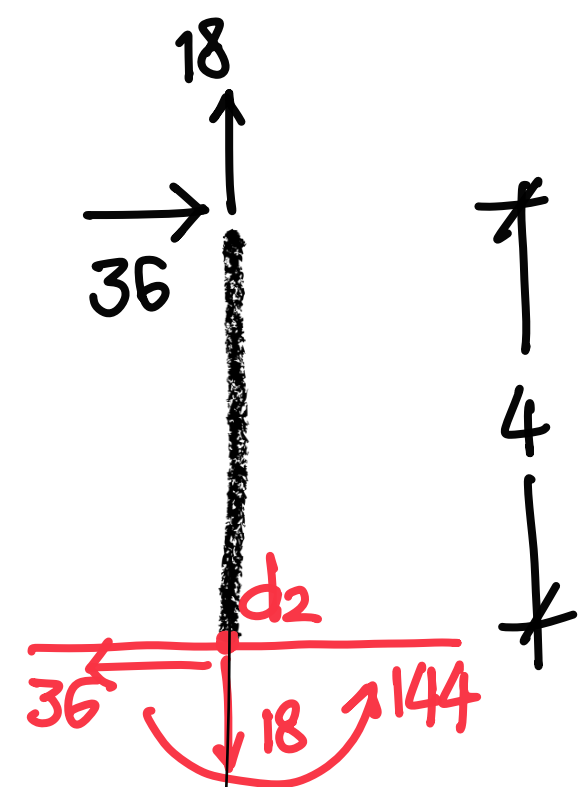
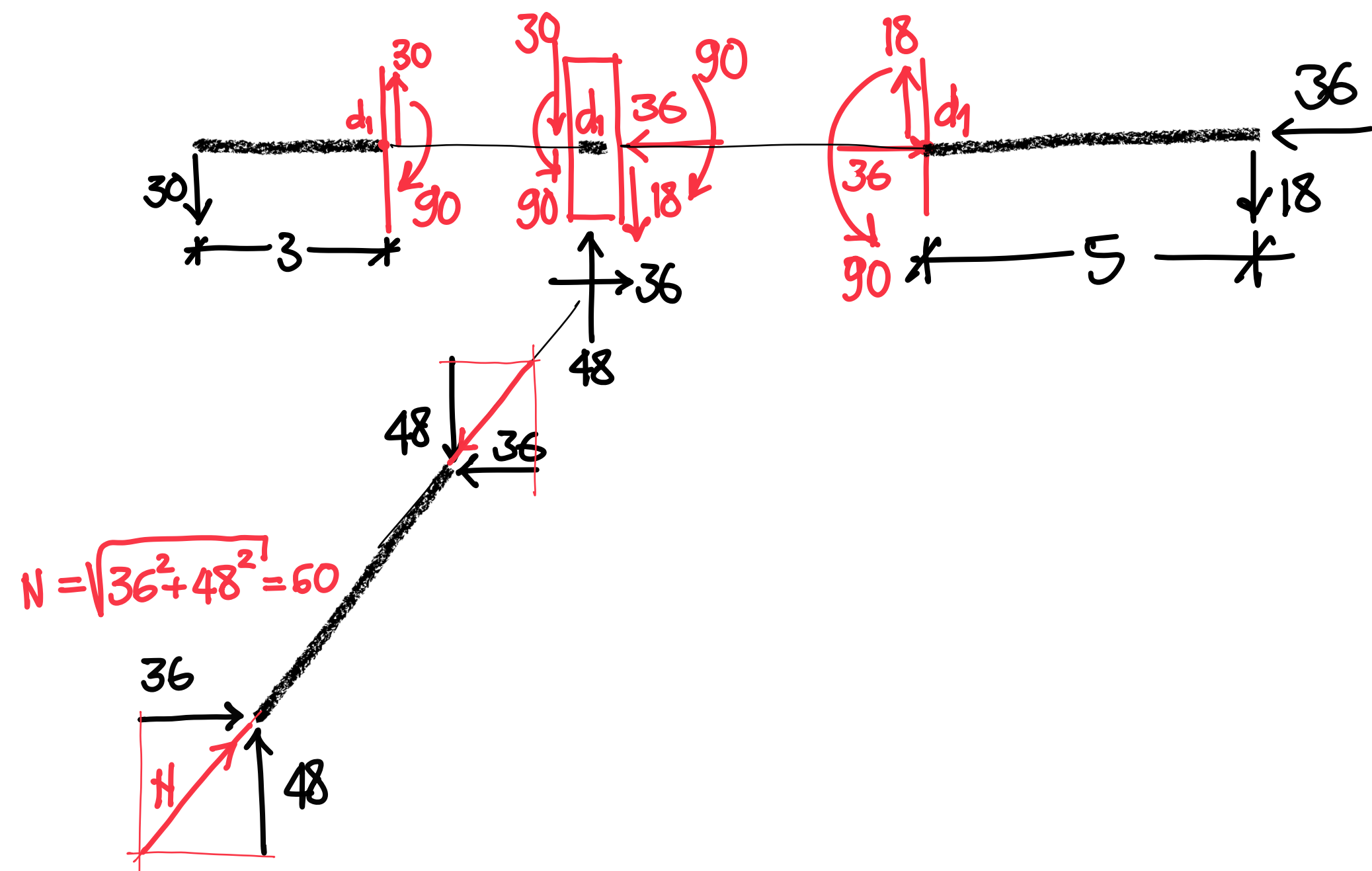
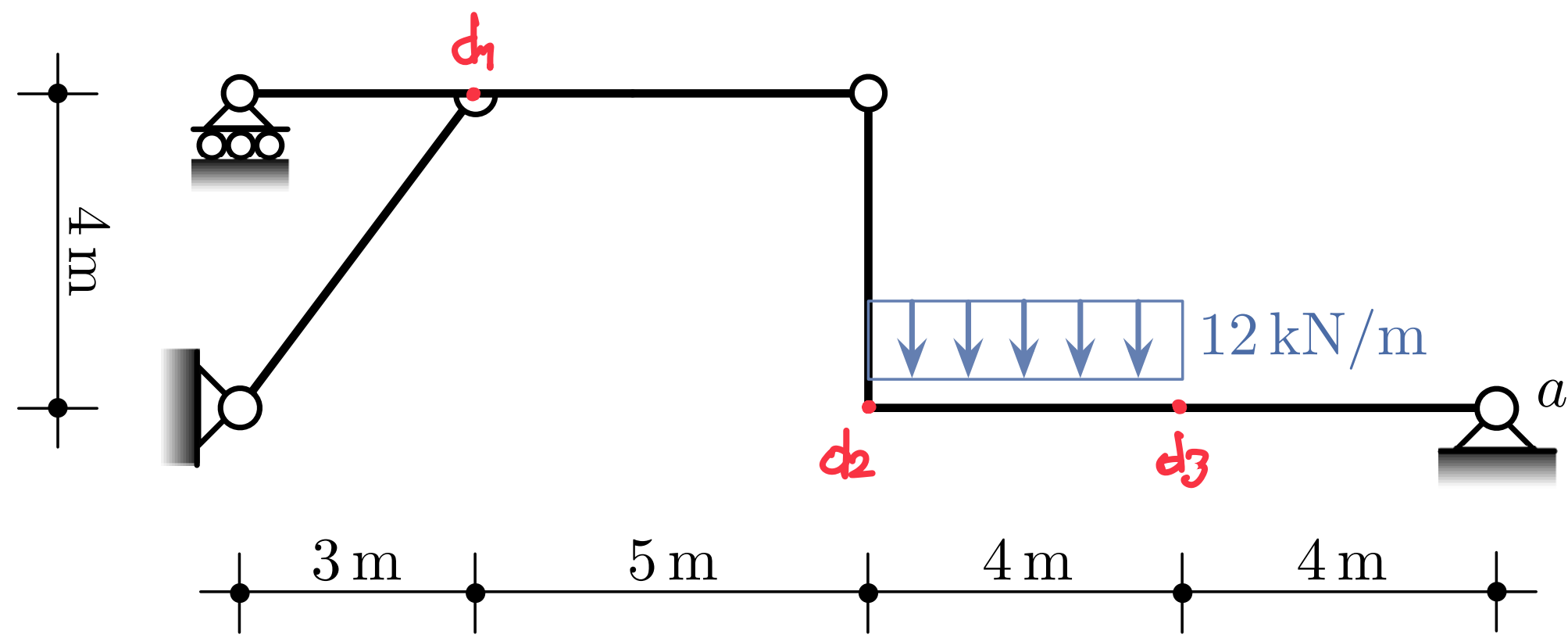

$$= 144 + 48 \times 2 - 30 \times 4$$



# DIAGRAMMI delle SOLLECITAZIONI

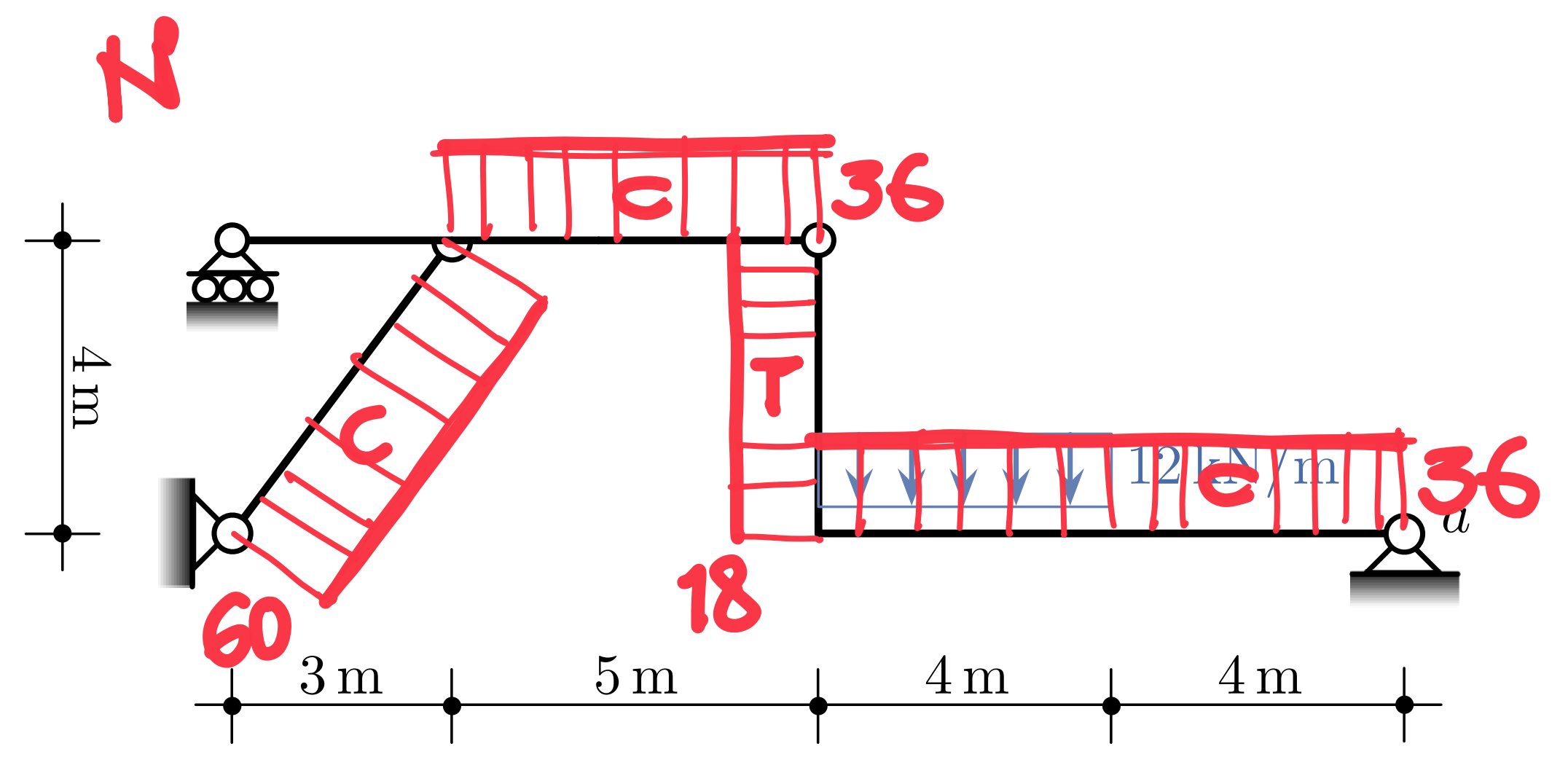

**T**

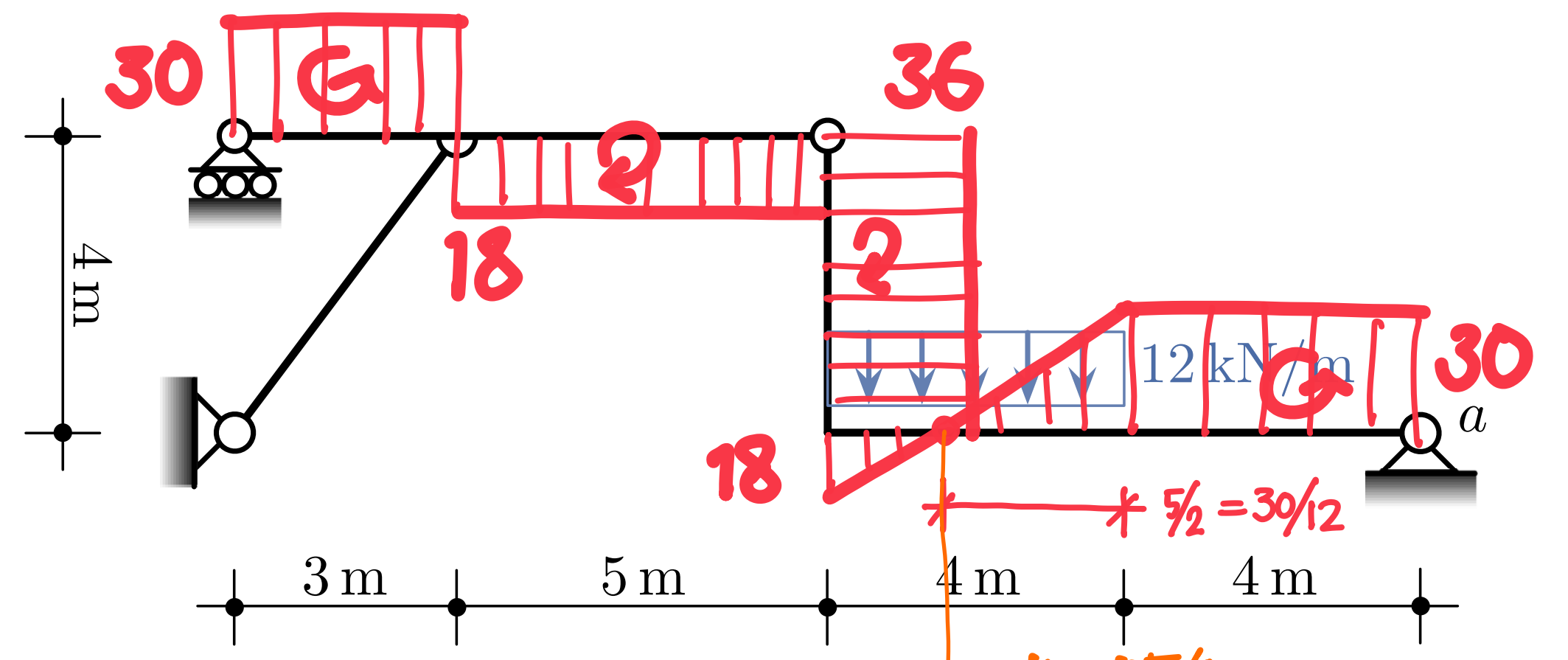

**M**

